

FCX1053A

SOT89 NPN medium power transistor

Summary

$BV_{CEO} = 75V$

$R_{CE(sat)} = 78m\Omega$

$I_C = 3A$

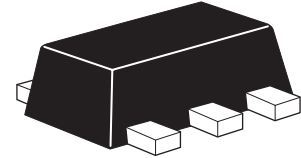

Description

This medium power NPN transistor, offered in the SOT89 package provides high current and low saturation voltage making it ideal for use in various driving and power management applications.

Features

- Extremely low equivalent on-resistance; $R_{CE(sat)} = 7.8m\Omega$ at 4.5A
- 3 Amps continuous current
- Up to 10 amps peak current
- Very low saturation voltages
- Excellent h_{FE} characteristics up to 10 amps

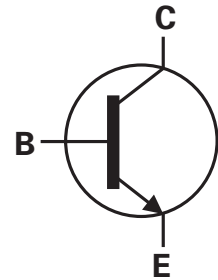

Applications

- Emergency lighting circuits
- Motor driving (including DC fans)
- Solenoid, relay and actuator drivers
- DC-DC modules
- Backlight inverters
- Power switches
- MOSFET gate drivers

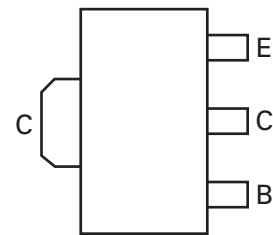

Pinout - top view

Ordering information

Device	Reel size (inches)	Tape width (mm)	Quantity per reel
FCX1053ATA	7	12	1,000

Device marking

053

FCX1053A

Absolute maximum ratings

Parameter	Symbol	Value	Unit
Collector-base voltage	V_{CBO}	150	V
Collector-emitter voltage	V_{CEO}	75	V
Emitter-base voltage	V_{EBO}	5	V
Continuous collector current ^(a)	I_C	3	A
Peak pulse current	I_{CM}	10	A
Power dissipation at $T_{amb} = 25^{\circ}C^{(a)}$	P_D	1.6	W
Linear derating factor		13	mW/°C
Power dissipation at $T_{amb} = 25^{\circ}C^{(b)}$	P_D	2.0	W
Linear derating factor		16	mW/°C
Operating and storage temperature range	$T_j; T_{stg}$	-55 to +150	°C

Thermal resistance

Parameter	Symbol	Value	Unit
Junction to ambient ^(a)	$R_{\theta JA}$	72	°C/W
Junction to ambient ^(b)	$R_{\theta JA}$	62	°C/W

NOTES:

(a) For a device surface mounted on 25mm x 25mm x 1.6mm FR4 PCB with high coverage of single sided 1oz copper, in still air conditions.

(b) For a device surface mounted on 50mm x 50mm x 1.6mm FR4 PCB with high coverage of single sided 1oz copper, in still air conditions.

Thermal characteristics

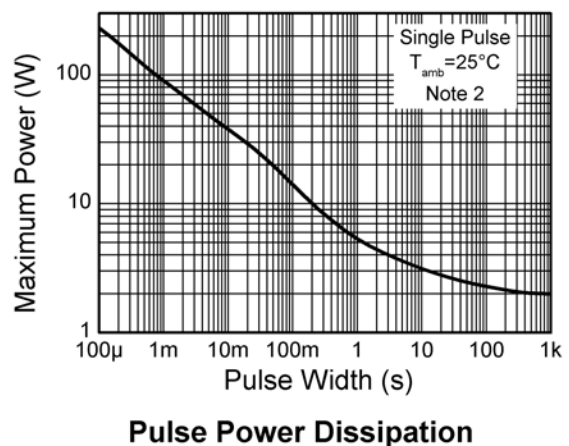
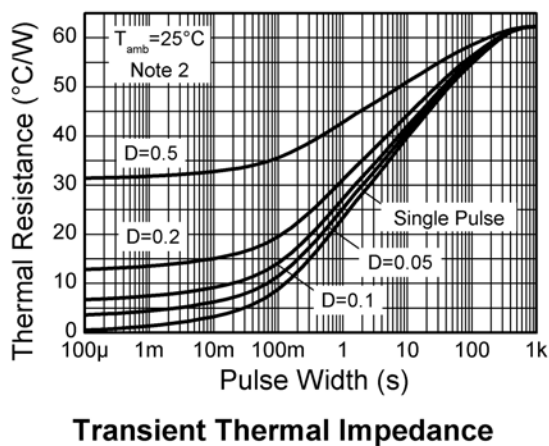
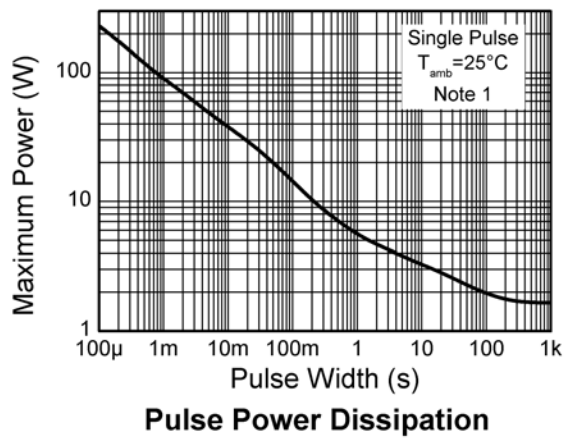
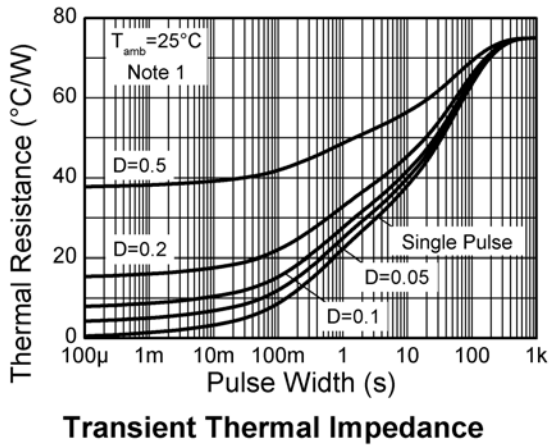
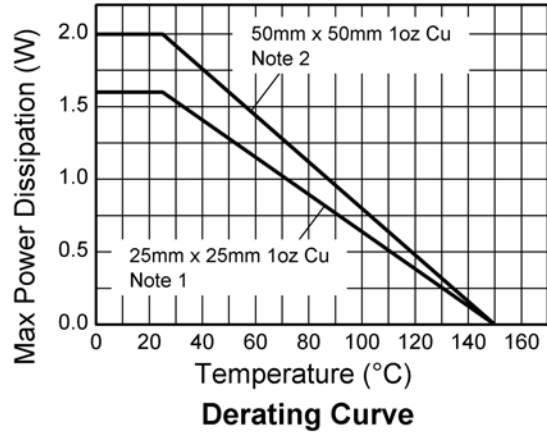
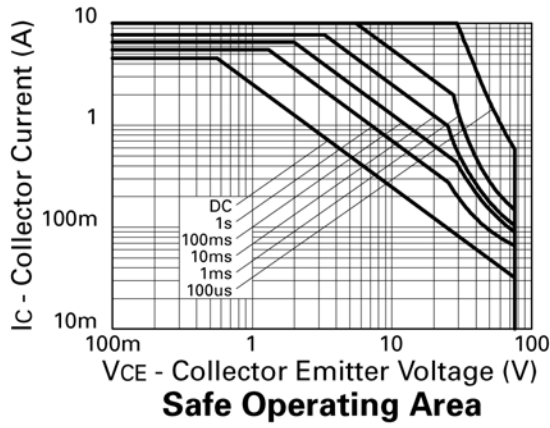

FCX1053A

Electrical characteristics (at $T_{amb} = 25^{\circ}\text{C}$ unless otherwise stated)

Parameter	Symbol	Min.	Typ.	Max.	Unit	Conditions
Collector-base breakdown voltage	$V_{(BR)CBO}$	150	250		V	$I_C = 100\mu\text{A}$
Collector-emitter breakdown voltage	V_{CES}	150	250		V	$I_C = 100\mu\text{A}$
Collector-emitter breakdown voltage	V_{CEO}	75	100		V	$I_C = 10\text{mA}$
Collector-emitter breakdown voltage	V_{CEV}	150	250		V	$I_C = 100\mu\text{A}, V_{EB} = 1\text{V}$
Emitter-base breakdown voltage	$V_{(BR)EBO}$	5	8.8		V	$I_E = 100\mu\text{A}$
Collector cut-off current	I_{CBO}		0.9	10	nA	$V_{CB} = 120\text{V}$
Emitter cut-off current	I_{EBO}		0.3	10	nA	$V_{EB} = 4\text{V}$
Collector-emitter cut-off current	I_{CES}		1.5	10	nA	$V_{CES} = 120\text{V}$
Collector-emitter saturation voltage	$V_{CE(sat)}$		21	30	mV	$I_C = 0.2\text{A}, I_B = 20\text{mA}^{(*)}$
			55	75	mV	$I_C = 0.5\text{A}, I_B = 20\text{mA}^{(*)}$
			150	200	mV	$I_C = 1\text{A}, I_B = 10\text{mA}^{(*)}$
			160	210	mV	$I_C = 2\text{A}, I_B = 100\text{mA}^{(*)}$
			350	440	mV	$I_C = 4.5\text{A}, I_B = 200\text{mA}^{(*)}$
Base-emitter saturation voltage	$V_{BE(sat)}$		900	1000	mV	$I_C = 3\text{A}, I_B = 100\text{mA}^{(*)}$
Base-emitter turn-on voltage	$V_{BE(on)}$		825	950	mV	$I_C = 3\text{A}, V_{CE} = 2\text{V}^{(*)}$
Static forward current transfer ratio	h_{FE}	270	440			$I_C = 10\text{mA}, V_{CE} = 2\text{V}^{(*)}$
		300	450	1200		$I_C = 0.5\text{A}, V_{CE} = 2\text{V}^{(*)}$
		300	450			$I_C = 1\text{A}, V_{CE} = 2\text{V}^{(*)}$
		40	60			$I_C = 4.5\text{A}, V_{CE} = 2\text{V}^{(*)}$
			20			$I_C = 10\text{A}, V_{CE} = 2\text{V}^{(*)}$
Switching times	t_{on}		162		ns	$I_C = 2\text{A}, I_{B1} = I_{B2} = \pm 20\text{mA}, V_{CC} = 50\text{V}$
	t_{off}		900		ns	$I_C = 2\text{A}, I_{B1} = I_{B2} = \pm 20\text{mA}, V_{CC} = 50\text{V}$
Transition frequency	f_T		140		MHz	$I_C = 50\text{mA}, V_{CE} = 10\text{V}, f = 100\text{MHz}$
Output capacitance	C_{OBO}		21	30	pF	$V_{CB} = 10\text{V}, f = 1\text{MHz}$

NOTES:

(*) Measured under pulsed conditions. Pulse width = $300\mu\text{s}$. Duty $\leq 2\%$.

Typical characteristics

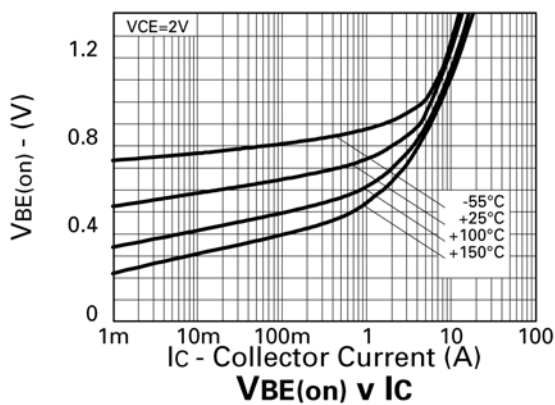
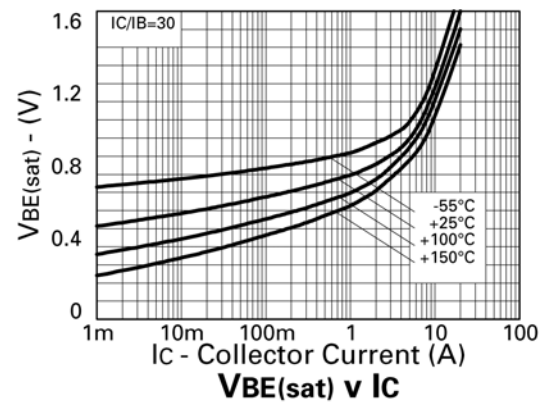
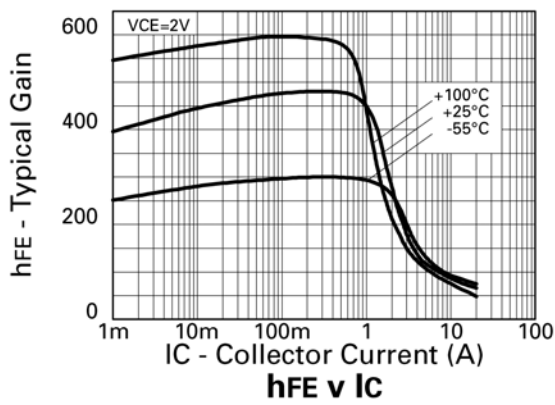
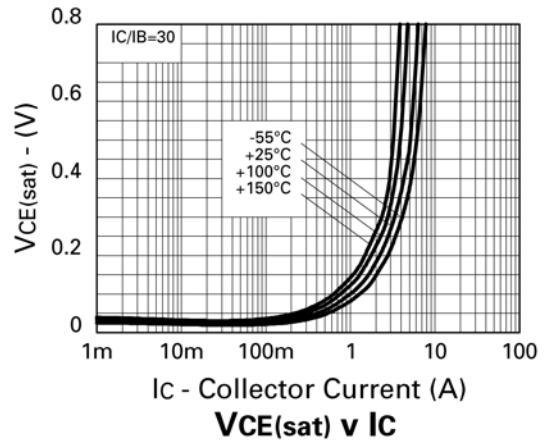
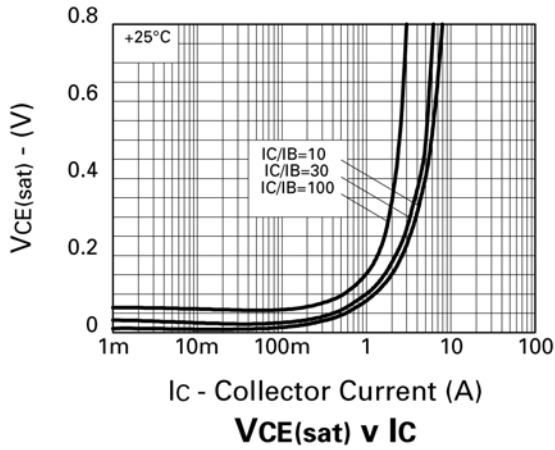

FCX1053A

Package outline - SOT89

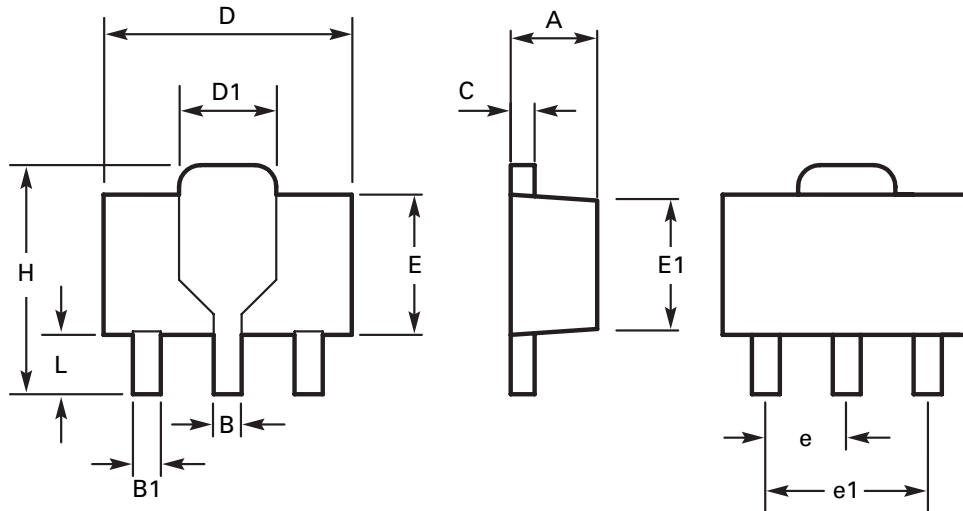

DIM	Millimeters		Inches		DIM	Millimeters		Inches	
	Min	Max	Min	Max		Min	Max	Min	Max
A	1.40	1.60	0.550	0.630	E1	2.13	2.29	0.084	0.090
B	0.44	0.56	0.017	0.022	e	1.50 BSC		0.059 BSC	
B1	0.36	0.48	0.014	0.019	e1	3.00 BSC		0.118 BSC	
C	0.35	0.44	0.014	0.019	H	3.94	4.25	0.155	0.167
D	4.40	4.60	0.173	0.181	L	0.89	1.20	0.155	0.167
E	2.29	2.60	0.090	0.102		-	-	-	-

Note: Controlling dimensions are in millimeters. Approximate dimensions are provided in inches

Europe

Zetex GmbH
Streitfeldstraße 19
D-81673 München
Germany

Telefon: (49) 89 45 49 49 0
Fax: (49) 89 45 49 49 49
europe.sales@zetex.com

Americas

Zetex Inc
700 Veterans Memorial Highway
Hauppauge, NY 11788
USA

Telephone: (1) 631 360 2222
Fax: (1) 631 360 8222
usa.sales@zetex.com

Asia Pacific

Zetex (Asia Ltd)
3701-04 Metroplaza Tower 1
Hing Fong Road, Kwai Fong
Hong Kong

Telephone: (852) 26100 611
Fax: (852) 24250 494
asia.sales@zetex.com

Corporate Headquarters

Zetex Semiconductors plc
Zetex Technology Park, Chadderton
Oldham, OL9 9LL
United Kingdom

Telephone: (44) 161 622 4444
Fax: (44) 161 622 4446
hq@zetex.com

For international sales offices visit www.zetex.com/offices

Zetex products are distributed worldwide. For details, see www.zetex.com/salesnetwork

This publication is issued to provide outline information only which (unless agreed by the company in writing) may not be used, applied or reproduced for any purpose or form part of any order or contact or be regarded as a representation relating to the products or services concerned. The company reserves the right to alter without notice the specification, design, price or conditions of supply of any product or service.